

MICRO-GENERATOR FOR ULTRA MICRO GAS TURBINE

O. Dessornes^{1*}, C. Zwysig²

¹Onera, Palaiseau, France

²Celeroton, Zürich, Switzerland

*Presenting Author: Olivier.Dessornes@onera.fr

Abstract: This paper reports the specification, the design, fabrication, and testing of a permanent-magnet generator suited for an ultra micro-gas turbine rotating at 840 000 rpm. At this rotation speed, this micro turbine designed by Onera should deliver 55 W. The generator itself was successfully realized and tested by Celeroton, following Onera's specifications. The mechanical to electrical conversion efficiency is 93%.

Keywords: micro turbine, micro generator, permanent magnet

INTRODUCTION

Due to the increase in micro-power requirements, many efforts have been done over the past decade to build a micro heat engine able to produce electricity. Among those systems, Onera decided to focus on the ultra micro gas turbine concept which seems very promising [1], [2]. Ultra micro gas turbines can indeed deal with power in between few tens of watts up to kW with high specific energy. More precisely the work that was done deals with a 50 W micro gas turbine. The first studies were mostly dedicated to the energetic behaviour of such engine to have a better understanding of the key points to address from an energetic point of view which led to a 10 mm diameter turbine rotating at 840 000 rpm. Figure 1 shows the final concept that will be tested in the Onera laboratory in 2011.

As it can be seen, this concept cannot provide any electricity since the generator is not yet implemented

in this design. For a complete micro turbine system, the electric generator has to be connected to the compressor which will lead to modify the air inlet. However, based on the foreseen performances, the generator was studied, built and tested apart of this system in order to demonstrate the feasibility of such a generator.

GENERATOR SPECIFICATIONS

The turbine and compressor computations performed at Onera showed that the net power that should be delivered by the micro turbine is 55 W at 840 000 rpm. The turbine and the compressor diameter is 10 mm and the compressor is made out of titanium. The required specifications for the generator are summarized in Table 1.

Finally, since the generator test set up is not equipped with gas bearings as the final ultra micro gas turbine but with high speed ball bearings, the maximum asked rotation speed for testing was 700 000 rpm instead of the nominal 840 000 rpm.



Figure 1 - Ultra micro gas turbine concept.

Table 1: generator specifications

Quantity	Value
Generator rating	
Rated power	55 W
Rated speed	840 000 rpm
Generator mechanical restrictions	
Maximal outer diameter	25 mm
Maximal length	20 mm
Maximal shaft diameter	4.5 mm
Generator shaft	
Shaft material	Titanium
Generator lifetime	
Cycles of 30 minutes	100
Generator efficiency	
Minimal electrical efficiency	80%

GENERATOR DESIGN

The machine rotor that connects to the micro turbine shaft consists of a cylindrical permanent magnet encased in a titanium sleeve. The sleeve material has a high strength to density ratio which allows for a stress limitation in the brittle permanent magnet with a shrink-fit. The magnet material is $\text{Sm}_2\text{Co}_{17}$ due to its superior temperature characteristics which tolerates temperatures up to $300\text{ }^\circ\text{C}$. The machine stator consists of a slot less winding along with an iron core. This configuration allows for a loss reduction especially at very high rotational speeds.

Mechanical design

The mechanical shaft design has to limit the mechanical stresses in the entire rotor below the tensile strengths of the materials, which are 900 N/mm^2 for titanium and 120 N/mm^2 for the magnet. The shaft with the magnet encased in a sleeve can be modeled as a rotating disk according to [3]. The stress tensor then consists of an azimuthal and a radial component as shown in Figure 2. For an outer rotor diameter of 3.5 mm and a magnet diameter of 1.5 mm the calculation leads to the stress distribution depicted Figure 3. It can be seen that both in magnet and sleeve the stresses have a safety margin of at least a factor of two to the tensile strengths both at standstill and rated speed.

Electromagnetic design and optimization

The electromagnetic design has been made such that the magnetic flux density in the iron stays below 0.5 T in order to keep the high-frequency iron losses low. Furthermore, the winding is designed for a nominal torque of 0.63 mNm which corresponds to the nominal operating point of 55 W at $840,000\text{ rpm}$. With these specifications and the constraints given in Table 1 the machine has been optimized for highest efficiency with the Nelder-Mead simplex method [2]. The constraints are taken into account by giving the cost function, which in this case is the total losses, a high value if the design is not feasible. The resulting generator losses of this optimized design are summarized in Table 2. The total losses of 5.14 W lead to a calculated efficiency of 91% at the nominal operating point. The resulting outer generator dimensions are even slightly smaller than specified, resulting in a generator as depicted in Figure 4.

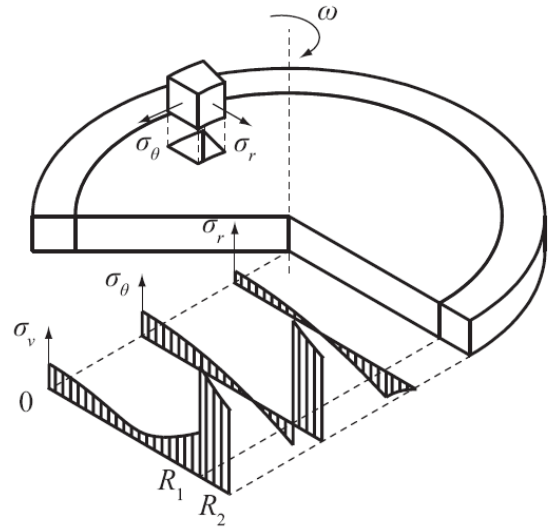

Figure 2 – Definition of the mechanical stresses in the generator shaft.

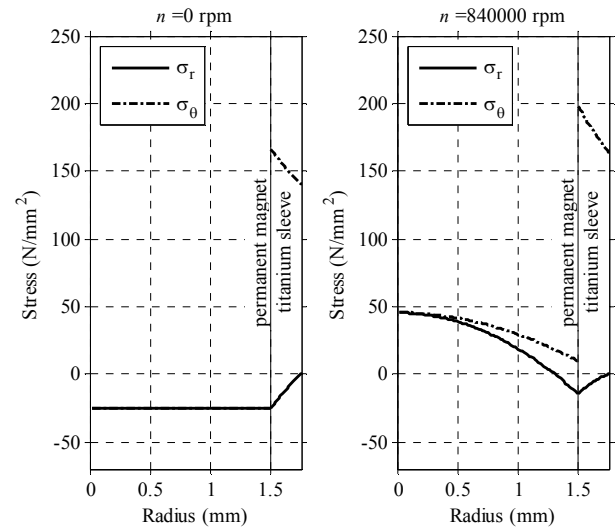

Figure 3 – Calculated stresses in the generator shaft.

Table 2: calculated generator losses

Symbol	Quantity	Value
$P_{Cu,dc}$	DC copper losses	2.26 W
$P_{Cu,ac}$	AC copper losses	0.07 W
P_{Fe}	Iron losses	0.18 W
$P_{f,air}$	Air friction losses	2.63 W
P_{tot}	Total losses	5.14 W

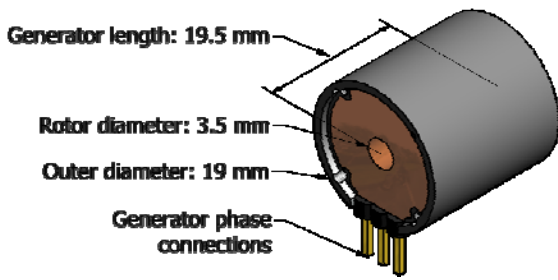

Figure 4 – Generator drawing and dimensions.

Rotordynamic design

The rotordynamic analysis is carried out for the generator shaft setup as used in the experimental verification of this paper, e.g. with ball bearings and no compressor or turbine connected. The rotordynamic analysis for the ultra micro gas turbine shaft will be carried out with the final shaft and bearing data.

The first goal of the rotor dynamic analysis is that the rated speed falls in between two critical speeds in order not to excite vibrations at rated operation. The second goal is to keep the first bending mode of the shaft higher than the rated speed with a safety margin of approximately 20%. This is due to the fact that the first two critical speeds are depending on the stiffness of the bearings, and they can be damped efficiently with the bearing setup. The first bending mode, however, which corresponds to the third critical speed (Figure 7), cannot be damped by the bearings and an operation close to that speed has to be avoided.

As can be seen from Figures 5-7 the generator is designed such that the rated speed of 840 000 rpm falls in between the second and third critical speed and is 18% away from the third critical speed (third bending mode of the shaft), which is a safe operating point. The colors indicate the areas of strongest bending. In Figure 8, the Campbell diagram shows that the eigenfrequencies of the rotor stay almost constant with rotational speed and therefore a calculation at zero speed is sufficient.

EXPERIMENTAL VERIFICATION

The measured generator parameters are summarized in Table 3, and compared when possible to the design parameters. It can be seen that the actual phase resistance is slightly lower than the designed resistance, and the flux linkage is slightly higher, both leading to lower dc copper losses in the generator at the operating point. This also increases the efficiency in the generator to 93%.

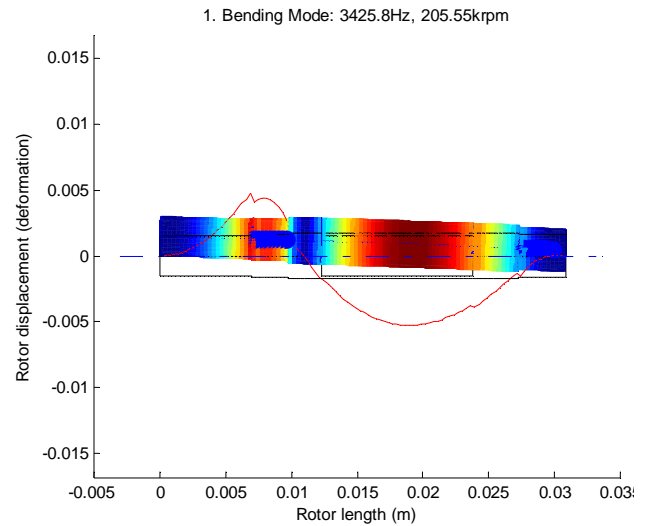

Figure 5 – First critical speed of the generator shaft.

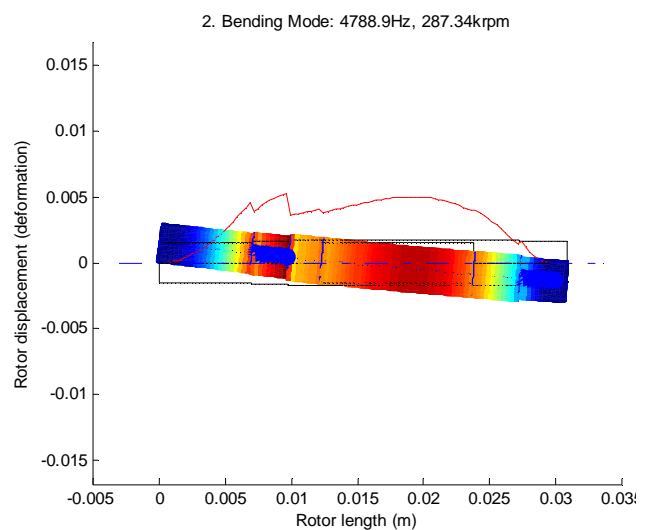

Figure 6 – Second critical speed of the generator shaft.

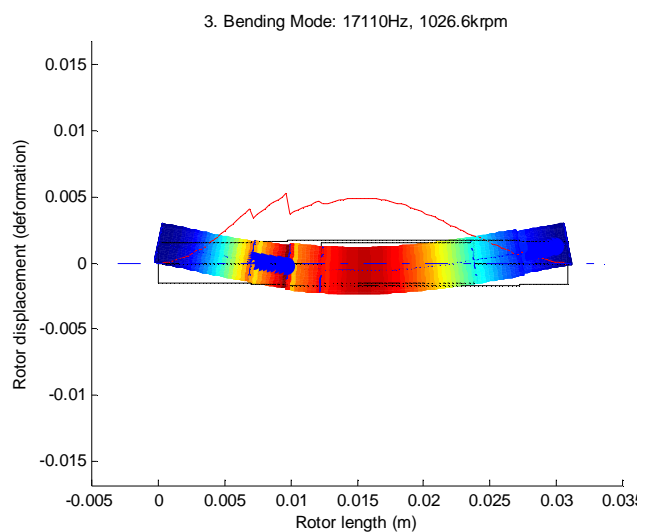

Figure 7 – Third critical speed and first bending mode of the generator shaft.

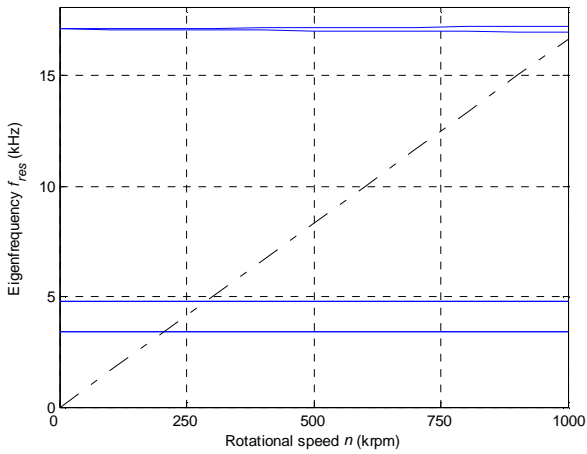

Figure 8 – Campbell diagram of the generator shaft.

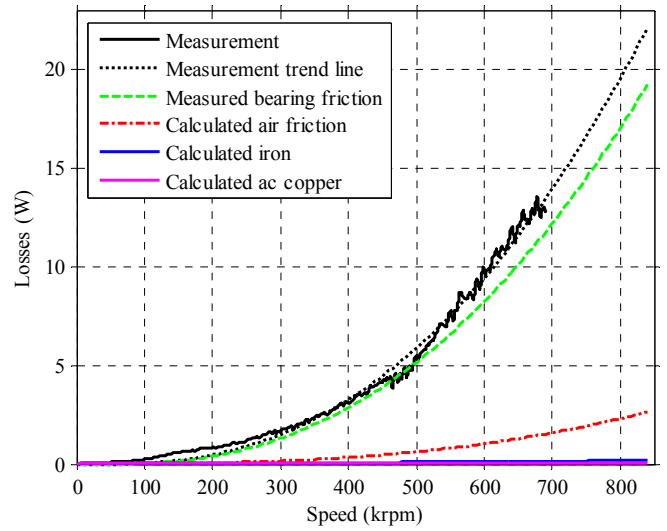

Figure 9 - Ultra micro gas turbine concept

Table 3: measured generator parameters

Symbol	Quantity	Designed Value	Measured Value
ψ_{PM}	Permanent-magnet flux linkage	0.275 mVs	0.292 mVs
R_{ph}	Phase resistance	0.59 Ω	0.41 Ω
L_{ph}	Phase inductance	-	11.3 μ H
$I_{ph,max}$	Rated phase current	1.07 A	1.01 A
$P_{Cu,dc}$	DC copper losses	2.26 W	1.25 W
m_r	Mass of shaft	1.70 g	-
J	Mass moment of inertia	2.64e-9 kgm^2	-

Deceleration test

The dc copper losses can be verified with measuring the flux linkage and the phase resistance at standstill. However, the high-frequency losses such as ac copper losses, iron losses and air friction losses are dependent on the rotational speed. Therefore, these losses are measured with the deceleration test. In this test, the rotor is spun up to 700,000 rpm. When the speed is reached, the converter is switched off. The speed dependent generator losses (ac copper losses, iron losses, air friction losses) and the bearing friction losses decelerate the rotor, and with the knowledge of the mass moment of inertia the losses can be determined by measuring the speed over time. From these losses, the bearing losses, which account for the major part of losses and are known from earlier measurements, are deducted, since they are not part of the electrical generator losses. In Figure 9 it can be seen that the sum of the calculated speed dependent losses plus the bearing losses match the measured total losses very well.

CONCLUSION AND PERSPECTIVES

Following ONERA's specifications, an electrical generator was designed by CELEROTON and successfully tested up to 700 000 rpm. The speed limitation was only due to the use of ball bearings that cannot withstand higher speed. Finally, this very compact generator has a mechanical to electrical conversion efficiency of 93%. This efficiency should be kept at the nominal 840 000 rpm speed of rotation. All the specifications were then fulfilled.

Using this generator as a motor, a new test set up will be built to map the compressor developed by Onera. The compressor should be indeed tested up to around 600 000 rpm and the experimental results will be compared to computations.

REFERENCES

- [1] J. Guidez, Y. Ribaud, O. Dessornes, T. Courvoisier, C. Dumand, T. Onishi, S. Burguburu, Micro gas turbine research at Onera, International Symposium on Measurement and Control in robotics, 2005, Brussels, Belgium
- [2] F.X Nicoul, T. Bouvet, J. Guidez, A study of the influence of a swirled injection on micro-scale non-premixed combustion, Powermems 2009, Washington, USA
- [3] Luomi, J.; Zwyszig, C.; Looser, A.; Kolar, J.W.; Efficiency Optimization of a 100-W 500,000-r/min Permanent-Magnet Machine Including Air-Friction Losses, *Industry Applications, IEEE Transactions on*, vol.45, no.4, pp.1368-1377, July-aug. 2009
- [4] S. P. Timoshenko and J. N. Goodier, Theory of elasticity. McGraw-Hill Kogakusha, Ltd. 1970, ch. 4.